

TREE CONSOLE

ASSEMBLY INSTRUCTION

W0UD

THE IDEA OF THE TREE TABLES CAME
UP DURING A WALK IN THE FOREST
AROUND PARIS. I WAS SEIZED BY THE
LIGHTNESS OF THE TREES AND I
WANTED TO REPRODUCE THIS
PHENOMENON. I THEN THOUGHT OF
A TABLE WHOSE TOP BOARD WOULD
FUNCTION LIKE THE CANOPY OF
TREES ALL THE WHILE BEING
SUPPORTED BY A BUNDLE OF STEMS.
HOPE YOU WILL ENJOY YOUR TABLE
FOR MANY YEARS TO COME.

A large, fluid, black handwritten signature that reads 'Elisabeth Herzfeld'. The signature is written in a cursive style with thick, expressive strokes. The 'E' is particularly large and loops around the start of the name. The 'H' and 'Z' are also prominent, and the 'feld' part is written in a more compact, rounded script.

ELISABETH HERZFELD

TAKE CARE

**WE HAVE NOW HANDED OVER
ONE OF OUR DARLINGS TO YOU.
NOW IT IS YOURS. TAKE GOOD
CARE OF IT. YOU CAN READ THE
CARE INSTRUCTIONS FOR ALL
OUR MATERIALS AT OUR WEBSITE.**

WOU.DK/TAKECARE

ASSEMBLY INSTRUCTION

**PLEASE GO THROUGH THE FOLLOWING
STEPS CAREFULLY. RETAIN THIS MANUAL
FOR FUTURE REFERENCE TO ENSURE THAT
YOUR NEW ITEM IS CORRECTLY ASSEMBLED
IN CASE IT SHOULD BE DISASSEMBLED OR
MOVED. WE ARE NOT RESPONSIBLE FOR
ANY FAULTS OR DAMAGES CAUSED BY
NOT FOLLOWING THESE INSTRUCTIONS
CORRECTLY.**

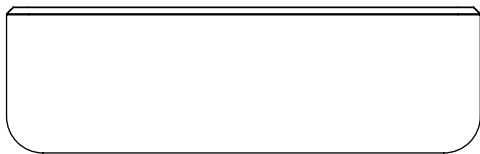

A X 1

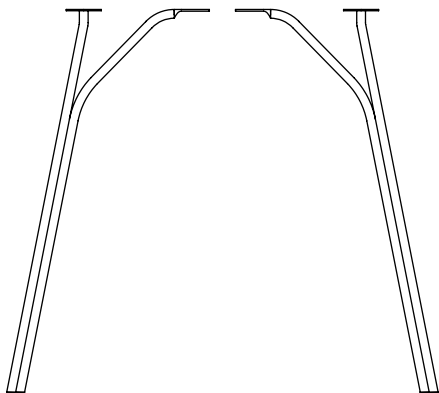

B X 2



C X 6



DX 8

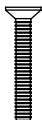

E X 10

TOOLS NEEDED

IMPORTANT!

USE TOOLS SUITABLE FOR SCREWS.

BE CAREFUL WHEN PLACING THE PRODUCT ON THE FLOOR WE RECOMMEND TO PUT A RUG DOWN FIRST.

USE WALL PLUGS AND DRILLS SUITABLE FOR YOUR WALL. BE CAREFUL WITH THIN/PLASTER/DRY WALLS AND SOLID CONCRETE WALLS. IN CASE OF DOUBT, WE RECOMMEND THAT YOU ASK A PROFESSIONAL.

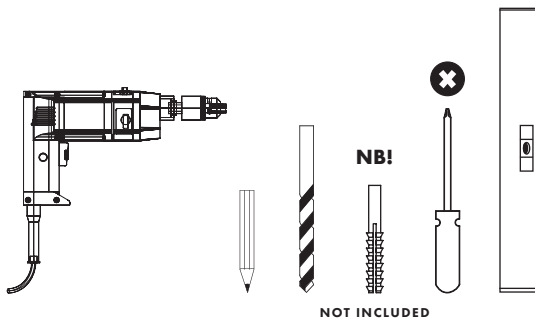

NB!

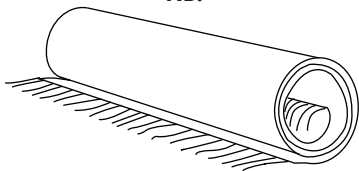

STEP 1

PLACE THE TABLE TOP (A) ON A RUG AND ASSEMBLE THE LEGS (B) WITH SCREWS (E). ATTACH THE TWO WALL BRACKET (D) UNDER THE TABLE TOP WITH SCREWS (C). USE ONLY HAND SCREW DRIVER!

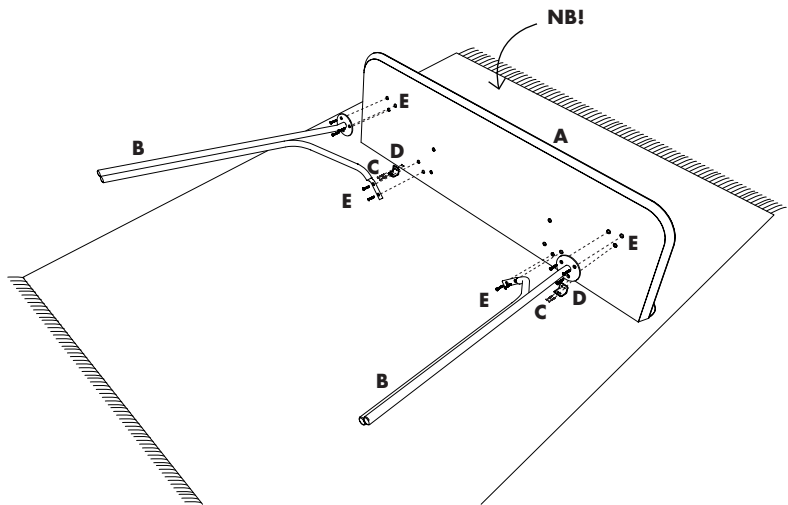

STEP 2

MARK THE HOLES WITH A PENCIL. MAKE SURE TO CHECK THE LEVEL BEFORE MARKING THE SPOTS. DRILL HOLES IN THE WALL AT THE MARKED SPOTS AND ADD THE PLUGS. THEN PLACE THE TABLE AGAINST THE WALL AND SCREW THE TABLE TO THE WALL

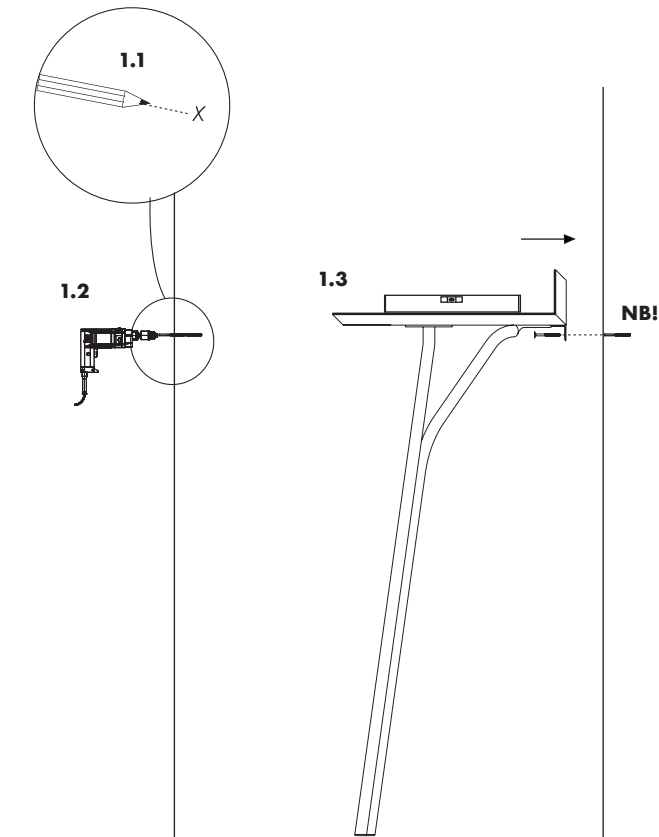

STEP 3

NOW YOU JUST NEED TO PLACE YOUR FAVORITE ITEMS
ON THE TABLE AND ENJOY.

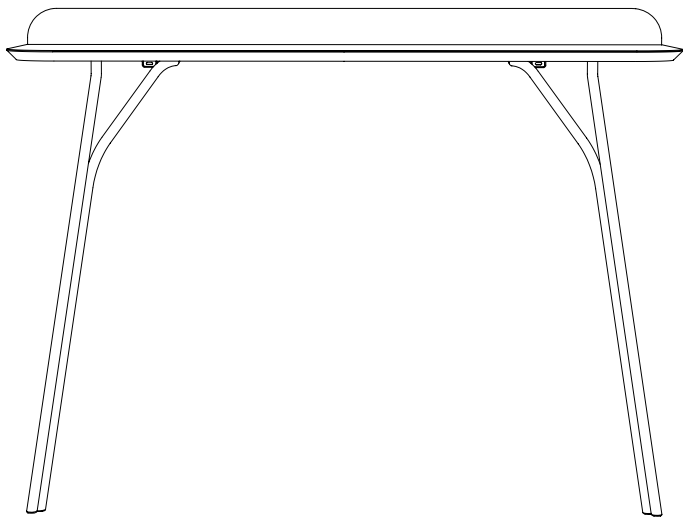

DESIGNED BY
ELISABETH HERTZFELD